



NAV350

OWNER'S GUIDE



3.5" Portable Navigation with MP3 player

Table of Contents

NAV 350 FEATURE HIGHLIGHTS	2
FIRST THINGS FIRST	4
SYSTEM TOUR	4
PERIPHERALS TOUR.....	8
NAV 350 SETUP.....	8
NAV 350 FUNDAMENTALS.....	15
HARDWARE INTERFACE	15
COMMAND INTERFACE.....	24
CONTACTS MANAGEMENT	26
CONTACTS	27
CONTACTS MANAGER.....	32
ACTIVESYNC	35
MULTIMEDIA MODE.....	37
MULTIMEDIA MODE OVERVIEW.....	37
MP3.....	37
PHOTO.....	42
SYSTEM CONFIGURATION	45
SYSTEM SETTINGS OVERVIEW	45
CUSTOMIZING USER PREFERENCES.....	46
SYSTEM MAINTENANCE AND USER SUPPORT.....	51
USING YOUR NAV 350 SAFELY.....	51
CLEANING THE NAV 350.....	54
TROUBLESHOOTING THE NAV 350	54
FAQS.....	58
CUSTOMER SUPPORT	60
SYSTEM SPECIFICATIONS.....	63
HARDWARE FEATURES	63
GPS SPECIFICATIONS	64
SOFTWARE SPECIFICATIONS	65
DESIGN AND ERGONOMICS	66
ENVIRONMENTAL SPECIFICATIONS.....	67
REGULATORY INFORMATION.....	67
INDEX	68

NAV 350

NAV 350 feature highlights

Powerful system

- Microsoft Windows CE .NET 4.2 operating system
- Samsung S3C2410 266 MHz application processor
- SiRF Star II LP chipset with Xtrac v2 firmware
- High-density rechargeable 2200 mAh Lithium Ion battery

Wide and accurate GPS coverage

- NAVTEQ digital map database
- Integrated patch antenna for optimum satellite pick up at every angle

Mobile design

- Compact and lightweight body makes it easy for users to carry it anywhere while driving or hiking
- Car mount kit for multi-vehicle usage (windshield or dashboard mounting)
- On-the-road recharging options via the car charger

Ergonomic features

- 3.5-inch 200-nit QVGA TMR LCD touch-sensitive screen
- Accessible control hot keys with backlight illumination
- Simple, easy-to-use user interface with large icons and command buttons
- Multi-language support for user interface
- Advanced power-saving options

Multimedia programs

- *MP3* for musical entertainment
- *Photo* for digital pictures

Contacts management programs

- Contacts for managing contact information on the device
- NAV 350 Contacts Manager for managing contact information on your computer
- Microsoft ActiveSync for synchronizing contact information

First things first

This chapter describes the hardware interface of the NAV 350 and its peripherals. Instructions for setting up the device and some basic system operations are also discussed.



System tour

This section describes operation of the device hardware interface.

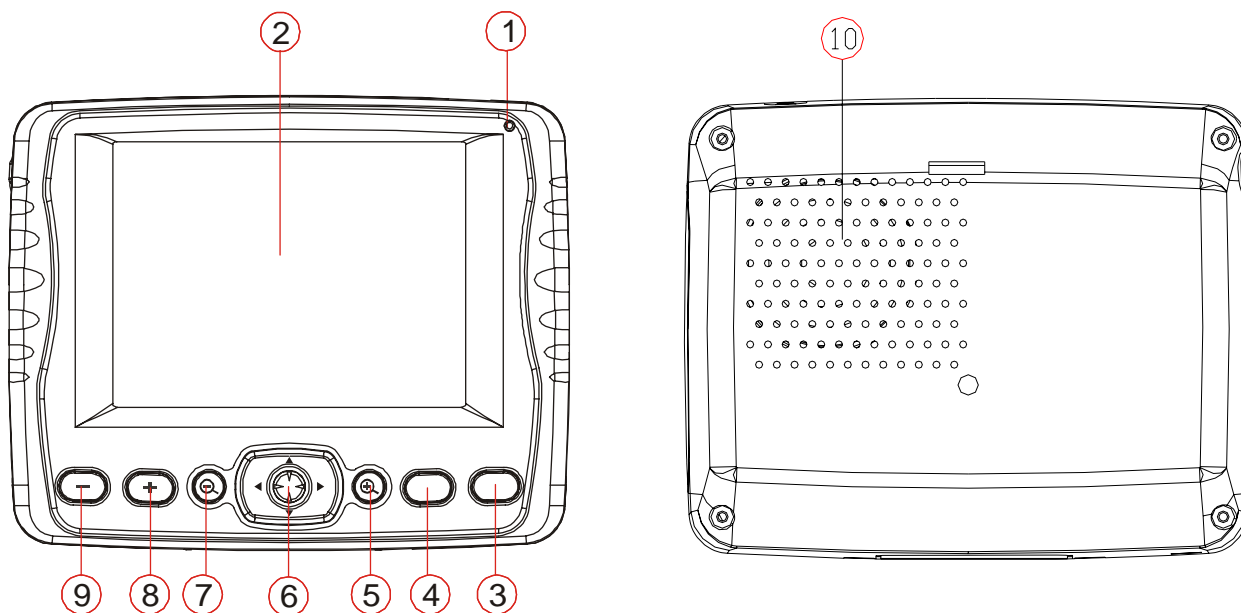
Rear and front panels







No.	Icon	Component	Description
1		Power status LED indicator	Indicates the battery power status. <ul style="list-style-type: none">• Green – Battery is fully charged; the device is running on battery power.• Orange – Battery charging• Red – Battery charge is near depletion level. You need to recharge your device.

No.	Icon	Component	Description
2		Touch screen	Displays the applications, data, and map images available on your device. It is touch-sensitive and responds to finger taps.
3	MENU	Main Menu hot key	Displays the Main Menu panel; also called the Home panel.
4	MAP	Navigation hot key	Displays the Navigation panel.
5		Zoom in hot key	When in navigation mode, zooms in on the center of a map. When in full screen mode in <i>Photo</i> , zooms in on the displayed image.
6		Multi-directional joystick	Move in a left-right or up-down direction to scroll through displayed items. Press to open (if it's a file icon) or launch (if it is a program or settings icon) a selected item.
7		Zoom out hot key	When in navigation mode, zooms out from the center of a map. When in full screen mode in <i>Photo</i> , zooms out on the displayed image.
8	+	Volume up hot key	Press to increase volume.
9	-	Volume down hot key	Press to decrease volume.
10		Speaker	Emits system sounds.

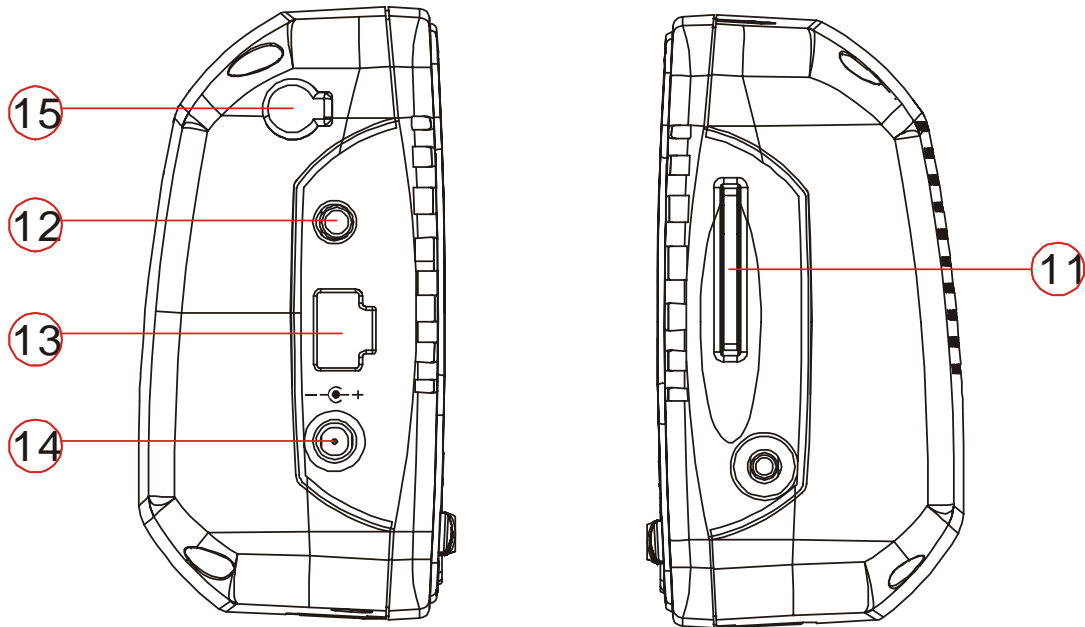
Note: For more information on how to use your NAV 350 in navigation mode, refer to the *Destinator OP Quick Start Guide* or the *Destinator OP User's Guide* (located in the *Destinator OP CD*).



Right and left panels

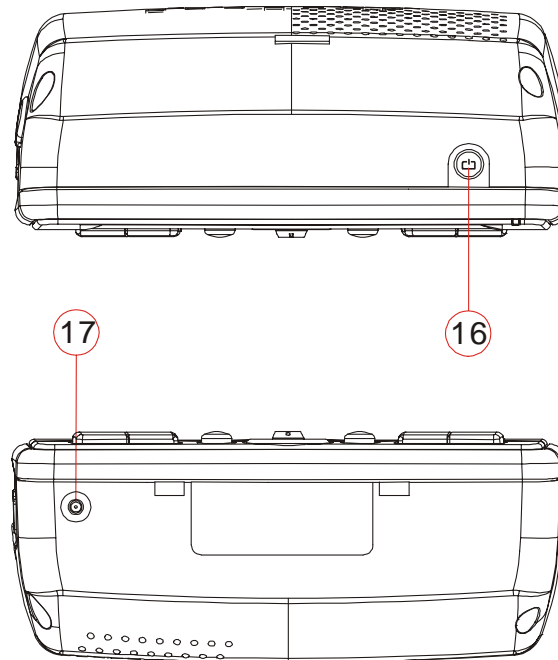

No.	Icon	Component	Description
11		SD/MMC slot	Accepts SD and MMC storage cards, allowing you to use audio, image, and map files stored in it for use with internal applications. You can also use it to back up data from your device.
12		Earphone jack	Connects to audio line-out devices (earphones/headphones).
13		USB port	Connects the device to computer running on the Microsoft Windows platform.
14		Power connector	Connects the device to an AC power outlet.
15		External antenna interface	Interface for an external GPS aerial

Top and bottom views



No.	Icon	Component	Description
16		Power button/ backlight control	As a power button: <ul style="list-style-type: none">• If the device is off, press the button to turn it on. The power LED indicator on the front panel lights up green.• If the device is on, press the button to turn it off. The power LED indicator also turns off. As a backlight control: <ul style="list-style-type: none">• Press and hold to activate or deactivate the screen backlight.
17		Soft reset button	Press to perform a soft reset if the device freezes (i.e., device no longer responds to the buttons on the screen).

Peripherals tour

This section describes of the peripherals bundled with the NAV 350.

Car charger

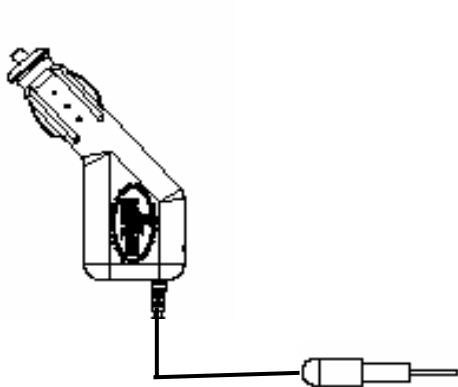

NAV 350 setup

Using the new NAV 350 is a snap. Unpack, mount, turn on, and it's ready to go. Perform the following easy installation tasks to start using the device straight out of the box:

1. Unpack the device.
2. Set up the device on a vehicle.
3. Turn on and configure the device.

Setup the NAV 350 on a vehicle

The NAV 350 comes with a car mount kit and a car charger with which you can set up the device on a vehicle. Choose a position for the car mount kit on the windshield using the suction cup, or on the dashboard using the self-adhesive power disc connector.



Some countries prohibit the mounting of any electronic device in any location on the vehicle dashboard. Be sure to check your local laws for acceptable mounting areas before installing the car mount bracket.



Some newer vehicle models may have a heat reflective shield embedded in the windshield. This may in some cases obstruct the GPS signal reception. If you encounter this problem in your vehicle, you need to purchase an external GPS antenna.

Car mount installation reminders

Install the car mount on the surface of a vehicle:

- That is smooth, flat and free of dirt and oil
- Where the driver can easily view/reach it without taking his/her eyes off too far from the road
- Where the device will not obscure car controls nor restrict the driver's view of the road
- Far from the air bag deployment area

To set up the device on a vehicle:

This section shows how to install the car mount kit in a vehicle's windshield using the suction cup. For dashboard installation procedures using the self-adhesive power disc connector refer to the *NAV 350 Portable Navigator Starter Guide*.

1. Clean the mounting surface with a glass cleaner and a clean cotton cloth.
2. If the ambient temperature is below +15°C (60°F) warm the mounting area and the suction cup (e.g. with a hair dryer) to ensure a strong suction bond.
3. Install the car mount on the selected area.
 - a. Fix the suction cup to the selected area with the locking lever facing up.
 - b. Flip the locking lever away from you to create a vacuum between the suction cup and the mounting surface.

c. Make sure that the suction bond is strong enough before proceeding to the next step.

d. Insert the pegs on the car mount's cradle plate to the holes on the back of the cradle, and then move the cradle downwards until both parts are engaged.

4. Insert the *Destinator OP SD card* into the device.

5. Dock the device on the cradle.



-
4. [Adjust the car mount](#) for the best viewing angle.
 5. After setting up the device on the car mount, connect the car charger.



If the car engine is turned off, you may be required to switch the vehicle ignition back into the Accessories position. Consult your vehicle owner's manual.

- e. Connect the car charger to the power connector on the cradle.
- f. Plug the other end of the car charger to your vehicle's cigarette lighter.
- g. The power LED indicator lights up orange during charging. The hot keys backlight is also lit up.



The device comes with the battery pre-charged to at least 30% capacity. You can start using it once it is mounted in your vehicle and connected to the cigarette lighter. However, for maximum usage time you need to charge your device to full capacity. Go to the "[Recharging the device](#)" section for instructions.

Start up the NAV 350

After mounting the NAV 350 on a vehicle it is ready to be used. Turn it on to calibrate the screen. After screen calibration, proceed to system settings configuration.

To turn on and calibrate the device:

Turn on the device by pressing the power button  on the top right panel of the device. The Main Menu panel displays. This is also referred to as the Home panel.



To configure system settings:



If you intend to start using NAV 350 at once, we recommend configuring the language and date/time settings first. The rest of the user preferences can be set up later.

1. Tap  On the Main Menu panel.

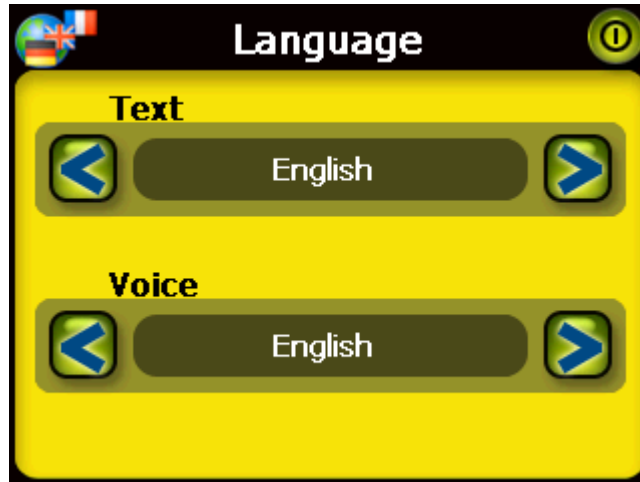

2. To set the system language settings, tap .





- h. Tap  /  under the Text and Voice settings until the language of your choice is displayed.
- i. Tap  to apply the changes made.

3. To set the system date and time, tap  .







4. Tap **Date**.

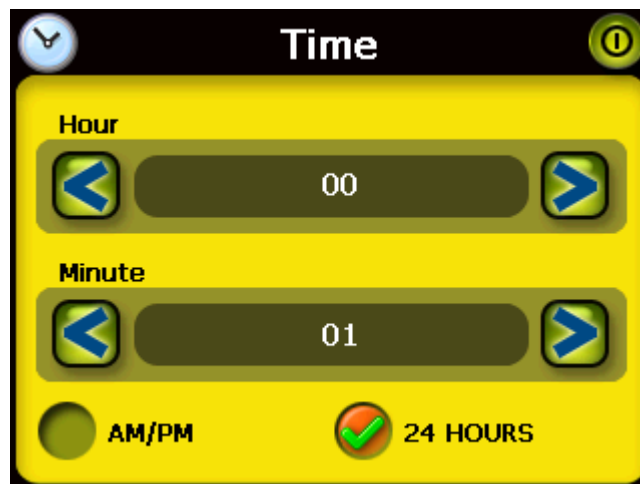

- j. Tap  /  under the Year, Month, and Day settings to set the date values.
- k. Tap  to apply the changes made.



5. Tap **Time**.

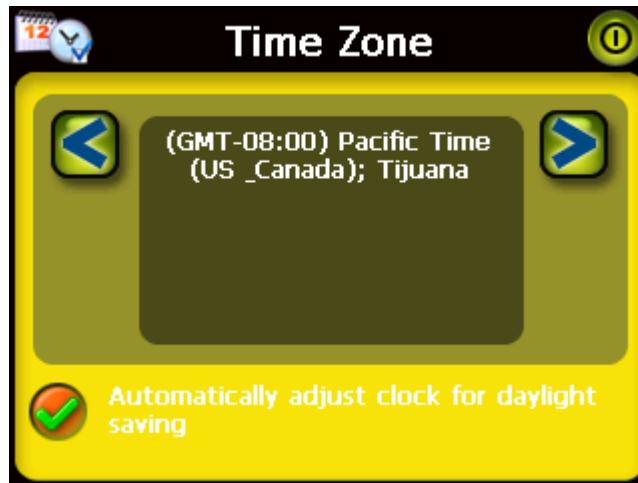

- l. a. Tap  /  under the Hour and Minute settings to set the time values.
- m. Tap  to apply the changes made.

6. Tap **Time Zone**.



- n. Tap  for the time zone of your choice.
 - o. Tap  to apply the changes made.
7. Tap  twice to apply the changes made, and return to the Main Menu panel.

For more information on the rest of the system configuration options, go to ["System configuration"](#).

Congratulations! Your new NAV 350 is now ready for use. Proceed to ["NAV 350 fundamentals"](#) for more information on the device's user interface to start using the device in navigation mode.

NAV 350 fundamentals

This chapter describes basic hardware procedures in using the NAV 350. Information on the device's command interface is also discussed.

Hardware interface

Using the touch screen backlight

Under some lighting conditions, viewing the information on the device may be difficult. If this is the case use the backlight to illuminate the touch screen.

To activate the touch screen backlight:

- Press and hold the power button  until the backlight turns on.

To turn off the touch screen backlight:

- Press and hold the power button  until the backlight turns off.

Using the SD/MMC slot

NAV 350 has an SD/MMC slot compatible with a range of SD and MMC storage cards that you can use to back up or transfer files and data.

Also, the NAV 350's GPS navigation system has its core on the Destinator OP program. Using this program requires that users load the digital maps available in the *Destinator OP SD card* included with the device.

To insert a storage card:

- Hold the device securely, and then push the card into the slot until you hear an audible system sound; this will signal that the card is already properly seated within the slot. The card is secure when it is not protruding from the slot.

To remove a storage card:

1. Hold the device securely, and then push against the top of the card, as if you were pushing it further into the slot, letting the card spring out. An audible system sound will signal that the card has been released.
2. Gently remove the card from the slot.

Establishing device-PC connection

The USB cable that comes with the device enables connection of the device to a computer. File Explorer displays the NAV 350 as a USB mass storage device, with the SD/MMC card shown as a sub-folder. Once connected, you can:

- Use File Explorer to copy digital music and image files into the device's SD/MMC card and access them when in Multimedia mode.

It is advisable to organize files into subfolders. This will served as playlists and albums when you access the files from your device.



To enable access of multimedia files from your device, it should be located on the SD/MMC card, not on the device's memory.

Go to "[Multimedia mode](#)" for more information on how to work in Multimedia mode.

- Use NAV 350 Contacts Manager to import/export contact information between your device and your computer
- Use ActiveSync to synchronize contact information located on the device and the computer

Refer to "[Contacts management](#)" for more information on contact information import/export as well as synchronization.

Installing Microsoft ActiveSync

Use Microsoft ActiveSync to exchange information between the NAV 350 and a computer running on the Microsoft Windows platform.



If you have a previous version of the Microsoft ActiveSync installed in your computer, uninstall it first before installing the latest Microsoft ActiveSync version.

You can download ActiveSync from Microsoft website.

Minimum installation requirements:

- Microsoft Windows XP, 2000, ME, and 98 SE
- Microsoft Outlook 2000 or later required for Contacts synchronization
- Microsoft Internet Explorer 5.0 or later
- Hard disk drive with 12 to 65 MB of available hard disk space
- Available USB port
- VGA graphics card or compatible video graphics adapter at 256 color or higher

Installing NAV 350 Contacts Manager

Use Contacts Manager to manage the contact information located on the device and on the computer. This PC program shares the same contact database as the Contacts component of Microsoft Outlook. It only has an import/export function; you still have to create contact entries in Microsoft Outlook Contacts.

To install Contacts Manager:

1. Insert the companion CD into PC ROM driver, select one language from the following languages: English, Français, Español, Portugues.



- b. After selecting language, one of the following pictures will appear:



-
1. Click Install Contacts Manager on the Please select your task screen.

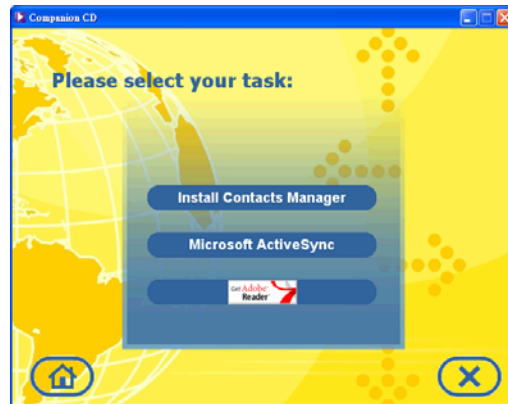

The installation wizard will automatically begin.

4. Follow the on-screen instructions.
5. Click **Finish** after the installation process is completed.

Creating a partnership

After completing the installation procedures, set up a partnership between the NAV 350 and the computer with the help of the New Partnership setup wizard.

Once you've created a partnership, you will be able to synchronize contact information using ActiveSync. Refer to the "[Synchronizing contacts](#)" section for more information.

To create a partnership:

1. If you want to upload files into an SD/MMC card for use with your NAV 350, insert the card to the device.
2. Connect the device to a computer using the bundled USB cable.
 - a. Plug the cable's smaller connector to the USB port  on the left panel of the device.
 - b. Plug the USB client connector into an available USB port on the computer.

The New Partnership setup wizard will automatically start on your computer screen.



3. Follow the onscreen instructions.
4. When prompted to select the items to be synchronized, select only **ContactSync**.

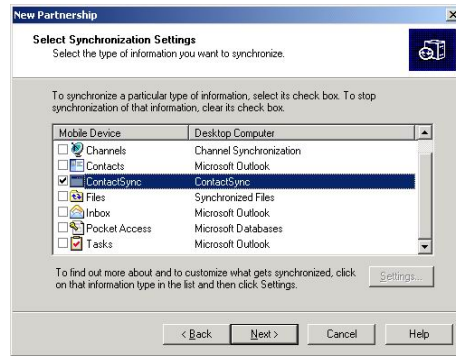

5. Click **Finish** on the Setup Complete dialog box.

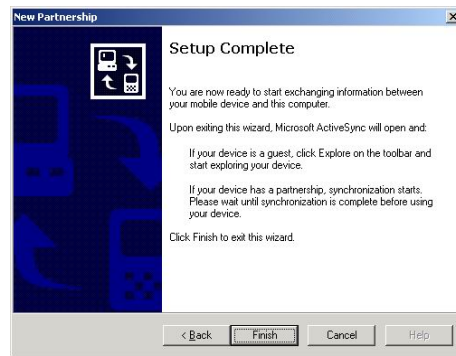

The initial synchronization process will automatically begin when finish using the wizard. After the initial synchronization, information you've stored in Microsoft Outlook Contacts on the computer will now be available on the NAV 350 without having to type a word.





6. Disconnect the device from the computer and you're ready to go.



Once you have completed the first synchronization process, you can initiate synchronization from your device anytime, using the USB cable.

Recharging the NAV 350

NAV 350 uses a high-density rechargeable 2200 mAh Lithium Ion battery. The status icon located on the top right corner of the Main Menu panel indicates the level of the device's battery power.

-  – Battery full charged
-  – Battery charging
-  – Battery level low
-  – Battery level very low, recharging required
-  – Battery power depleted, device will automatically turn off; recharging required. You

If the battery level becomes low in the course of normal use, recharge the device. Normally, please use the AC adapter to recharge the NAV 350. However, this may be difficult when there's no available AC power outlet on hand. When the device battery is drained while on the road, you can still recharge the device by using either the car charger cable or the USB cable bundled with the device. Recharging time from empty to full capacity is about six (6) hours in all cases.



If the battery level reaches very low status, the device will automatically turn off. In this case, you have about 12 hours to recharge your device after which you risk losing all data on the device's internal memory. In case all data is lost, the next time you power on the device you will be prompted to restore the data.

To recharge the device using the AC adapter:

1. Plug the AC adapter into any AC current outlet.
2. Connect the AC adapter cord to the power connector on the left panel of the device.

The power LED indicator lights up orange during charging. The hot keys backlight is also lit up.

3. Once charging is complete, as indicated when the power LED indicator lights up green, disconnect the AC adapter cord from the device.

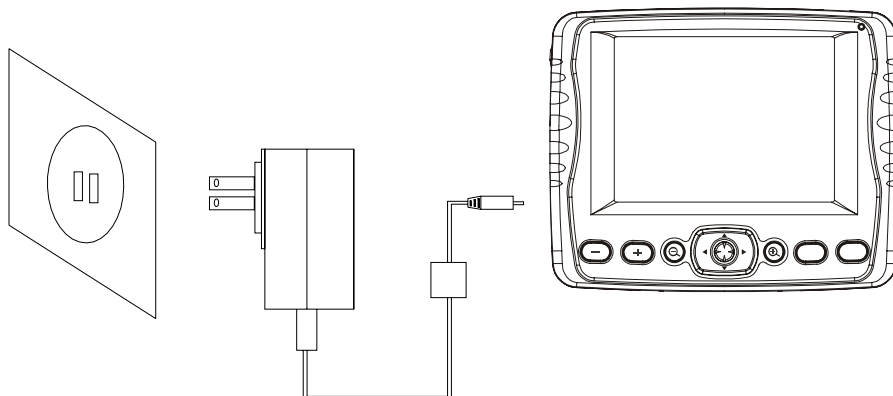

To recharge the device using the car charger:

Use the car charger to recharge the device while it is mounted on the vehicle. Perform step 7 of the "[To set up the device on your vehicle](#)" section for instructions.

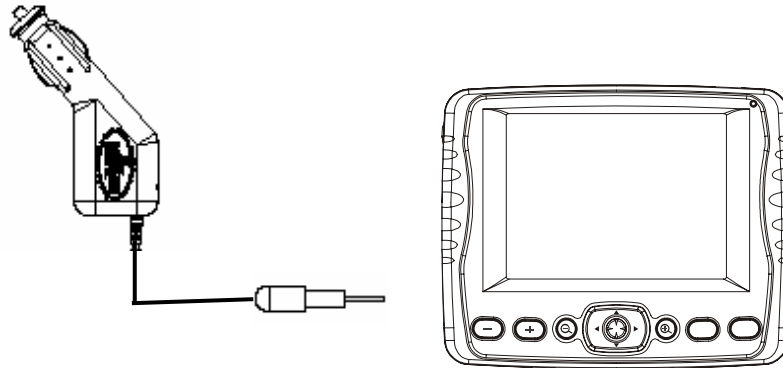

Command interface

Using the hot keys

The hot keys on the NAV 350 allow users to:

- +/- - Control the volume level of system sounds
- +/- - Control the magnification level of images
- **MAP**-Launch the Navigation panel
- **MENU**- Launch the Main Menu panel

All six hot keys light up when pressed for easier operation under low light conditions.



The function of the hot keys may be disabled in some screens. For example, the magnification level hot keys are inactive when viewing the *MP3* directory.

Using the joystick

The multi-directional joystick controls actions and scroll through functions in the device, and at the same time act as an Enter key when pressed.



The function of the joystick may be disabled in some screens. For example, the up/down direction is inactive when in *MP3* playback mode.

Using the NAV 350 touch screen

The NAV 350 touch sensitive screen allows for a more natural way of entering information into the device using fingers instead of a stylus—no more wasted time finding a lost stylus or fumbling with an awkwardly shaped one! In this Guide, the tap and hold-and-drag actions are done by:

- **Tap** - Touch the screen once with your finger to open items and select options.
- **Hold and drag** – Tap a slider icon and drag it across the screen. In *Photo*'s Full Screen mode, hold and drag the image to pan it in different directions.
- **Return** – Tap to apply any changes made and/or revert to the previous screen.



Using the Main menu panel

When the device turned on for the first time each day, you'll see the Main Menu panel, also called the Home panel. From any other screen, you can revert to it by pressing the Main Menu hot key **MENU**.



The panel's title bar displays the current time (with 24-hour notation), the panel name, and the battery power level status icon. Go to the "[Recharging the device](#)" section for more information on this status icon.

There are six program icons on the Main Menu panel.

-  – Tap to launch **MP3** for music mode operation. Go to "[Multimedia mode](#)" for more information.
-  – Tap to display the Navigation panel. Refer to the *Destinator OP User's Guide* for more information on how to use the device in navigation mode.
-  – Tap to launch **Photo** for picture mode operation. Go to "[Multimedia mode](#)" for more information.
-  – Tap to launch the Contacts program to access your contacts list. Refer to the *Destinator OP Quick Starter Guide* or the *Destinator OP User's Guide* for more information on how to use this program.
-  – Tap to open the System panel to configure the device's user preferences. Go to "[System configuration](#)" for more information.

Contacts management

This chapter discusses the basic functions of Contacts in the device. Details on how to perform contacts management tasks from a computer are also provided.

 Contact files imported/exported to the device and computer is saved in .fs format.

Contacts

Contacts maintains a list of your friends' and colleagues' contact information. These include email address, street address, multiple phone numbers, and other related information, such as birthday or anniversary date.

Contacts maintains a list of your friends' and colleagues' contact address. You can enter multiple address entries for each contact. This program is integrated with Destinator OP enabling users to treat all address entries as possible destination points in navigation mode.

Using Contacts

To open Contacts:



- Tap  on the Main Menu panel.

The Contacts control pad displays.



The control pad displays the list of contacts and several command buttons for performing various Contacts tasks.

Creating a new contact

1. Tap **New**.



2. Enter the related information for the new contact.
3. Tap **Save** to save the new contact.

Editing contact information

1. In the Contacts control pad, tap the contact you wish to edit.
2. Tap **Edit**.



3. Enter the new information for the contact.
4. Tap **Save** to save the new contact.

Navigating to a contacts address

1. In the [Contacts](#) control pad, tap the contact whose address you want to navigate to.
2. Tap **Navigate**.

Address entries for the selected contact appears.

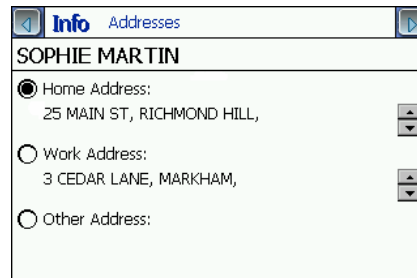

3. Tap the address you want to navigate to.
4. Tap **Navigate**.

Destinator OP plans your route. The calculated route is shown on the map as a blue line from your current GPS position.

For more information on how to work in navigation mode, refer to the *Destinator OP Quick Starter Guide* or the *Destinator OP User's Guide* (located in the *Destinator OP CD*).

Exporting contacts from your NAV 350

1. [Insert an SD or MMC storage card into the device.](#)

Exported contact file(s) will be saved to this storage card for later access from your computer.



2. Tap  in the [Contacts](#) control pad.



3. Select whether to export all contacts, or just the currently selected one.
Selected contact(s) will be exported to the SD/MMC card installed in your device.
4. Click **OK** on the completion dialog box.
Use Contacts Manager to import this contact file to your computer. Refer to the "[Importing contacts from your NAV 350](#)" section.

Importing contacts from your NAV 350:

1. [Insert the SD or MMC storage card](#) containing the contact file(s) you wish to import into the device.
Use Contacts Manager to export contact file(s) from your computer. Refer to the "[Exporting contacts from your NAV 350](#)" section.



2. Tap  in the Contacts control pad.



3. Tap the contact file you wish to import into your device.
4. Tap **Import**.
5. Click **OK** on the completion dialog box.
Selected contact file will be added to the Contacts list.

Deleting a contact

1. In the Contacts control pad, tap the contact you wish to delete.

-
2. Tap **Delete**.
 3. Tap **Yes** to confirm the deletion.

Contacts Manager

Use NAV 350 Contacts Manager to manage the contact information located on your device and on your computer. This PC program shares the same contact database as the Contacts component of Microsoft Outlook. It only has an import/export function; you still have to create contact entries in Microsoft Outlook Contacts.

For more information on how to use Microsoft Outlook Contacts on your computer, open Microsoft Outlook, press **F1**, type 'Using Contacts', then press **Enter**.

For instructions on how to install Contacts Manager on your computer, go to the "[To install Contacts Manager](#)" section.

Using Contacts Manager

Use Contacts Manager to export and import contact information between your NAV 350 and your computer.

To open Contacts Manager:

- Click **Start > Programs > NAV 350 > Contacts Manager**

The Contacts Manager main window displays.

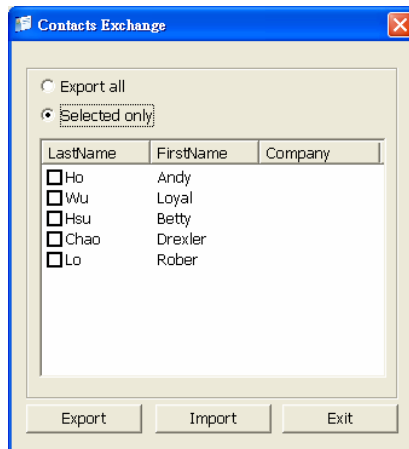

Exporting contacts from your computer

1. [Insert an SD or MMC storage card into the device.](#)

Exported contact file(s) will be saved to this storage card for later access from your device.

2. [Connect the device to your computer using the bundled USB cable.](#)
3. Open **File Explorer** to check that the device is now displayed as a USB mass storage device.
4. Click **Selected Only** on the Contacts Manager window.
5. Click the contact(s) you want to export.
6. Click **Export**.

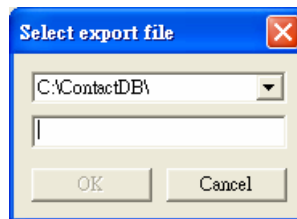

7. Select the drive name corresponding to the NAV 350.
8. Type a filename for the contact file.
9. Click **OK**.

Selected contacts will be exported to the SD/MMC card installed in your device.



10. Click **OK** on the completion dialog box.

Importing contacts from your NAV 350

1. [Insert the SD or MMC storage card](#) containing the contact file(s) you wish to import into the device.
2. Perform steps 2 through 4 of the previous section.
3. Click **Import**.

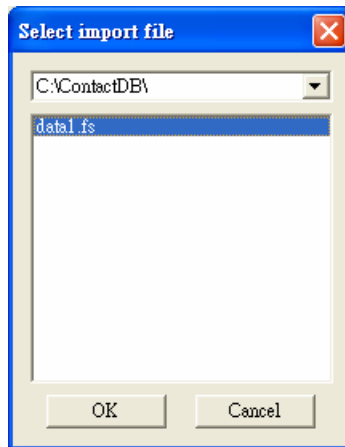

4. Select the drive name corresponding to the NAV 350.
5. Select the contact entries you want to import.
6. Click **OK**.

Contacts will now be imported to your computer.



7. Click **OK** on the completion dialog box.

Imported contact information will be added to your Microsoft Outlook Contacts list and be shared with Contacts Manager.



ActiveSync

Use ActiveSync to synchronize the contact information located on your NAV100 and your computer. Each time you synchronize, ActiveSync compares the information on your device with the information on your computer and updates both locations. This means you'll always have the most up-to-date contacts list wherever you are.

For instructions on how to install ActiveSync on your computer, go to the "[Installing Microsoft ActiveSync](#)" section.

Synchronizing contacts

Follow the instructions below to synchronize contact information located on your NAV 350 and your computer.

1. Perform steps 1 and 2 of the "[Exporting contacts from your computer](#)" section.
2. Double-click the ActiveSync icon  on your computer's system tray.
If the wizard does not automatically appear, launch ActiveSync on your computer by clicking on its icon from **Start**, then **Programs**.
3. Click **Options** , then the [Rules](#) tab to configure synchronization settings.

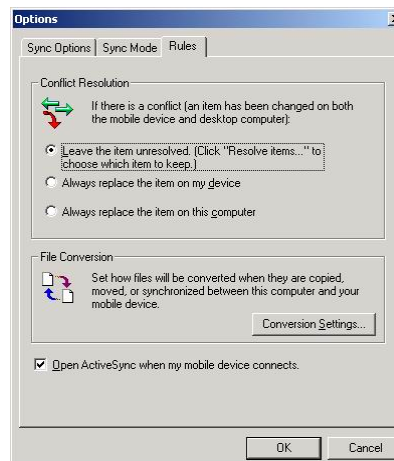

4. Select your preferred settings for the Conflict Resolution and File Conversion options.
5. Click **OK**.
The settings you've selected would apply to all future contacts synchronizations.
6. Click **Sync**  to start contacts synchronization.

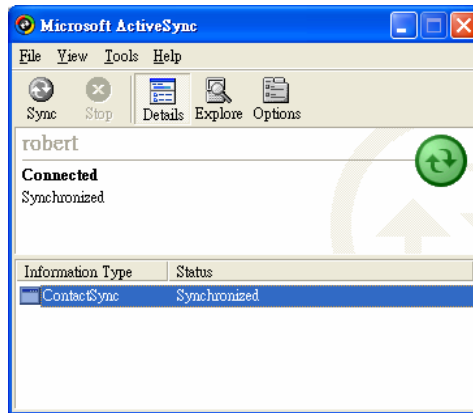

Contact information located on the NAV 350 and the computer will now be synchronized.

Multimedia mode

This chapter describes the multimedia programs bundled with your NAV 350.



The device's multimedia programs—*MP3* and *Photo*—are not available in navigation mode. This is for safety reasons so as not to distract the driver's attention from the road.

Multimedia mode overview

In addition to its navigating function, the NAV 350 is also a mobile entertainment device that lets you enjoy the digital music and image collection on the road. *MP3* and *Photo* extend the device's function to the multimedia scene.

To enable access of multimedia files from the device, it should be located on the SD/MMC card, not on the device's memory. Do this either by:

- Using the USB cable to connect the device, with the SD/MMC card inside, to a computer, and then use File Explorer to copy digital music and image files into the device's SD/MMC card folder.
- Using a compatible card reader to directly copy digital music and image files to the SD/MMC card.



It is advisable to organize files into subfolders. This will served as playlists and albums when you access the files from your device.

MP3

Enjoy your favorite music on the road. The program features:

- Support for MP3, and WAV files
- Auto-scanning of supported files in the device's SD/MMC card
- Separate volume control enabling you to adjust the playback sound level while retaining the volume level set for system sounds

- Hot key function for volume control
- Playlist support based on sub-directory contents

Each sub-directory containing compatible music files is treated as an individual playlist. For a more organized file search, it is advisable to named sub-directories based on genre or listening preferences. To illustrate, a sub-directory containing music you listen to when traveling can be named "Journey favorites"; or "Top alternative" for a sub-directory consisting of your favorite alternative songs.

- Shuffle and repeat playback functions

Using MP3

To open MP3:

- Tap  on the Main Menu panel.

The *MP3* playback pad displays.

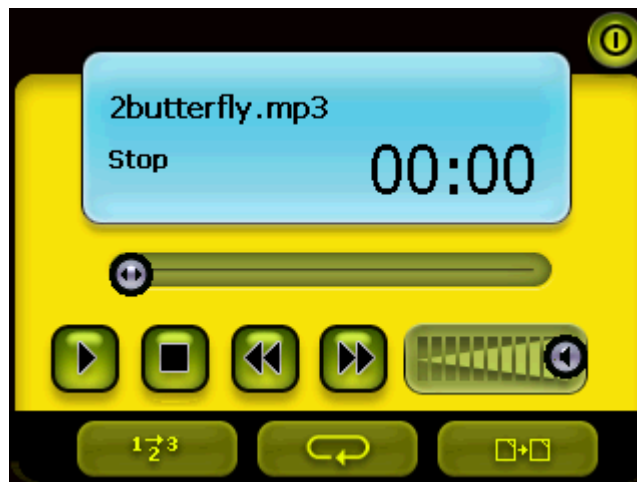

To open files for playback:

1. Tap **OPEN**.

The program will automatically scan the device SD/MMC card for supported digital files. Only sub-directories containing compatible music files will be displayed.

2. Search for the file you want to play.

Tap  /  or use the joystick to scroll through all available files.

3. Tap a file or press the joystick to start playback of the selected file.
 - o When the file is located in the root directory, tap the file for playback.
 - o When the file is located inside a sub-directory, tap the sub-directory icon, then tap a file for playback.

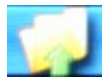

Tap  to return to the device's root directory.



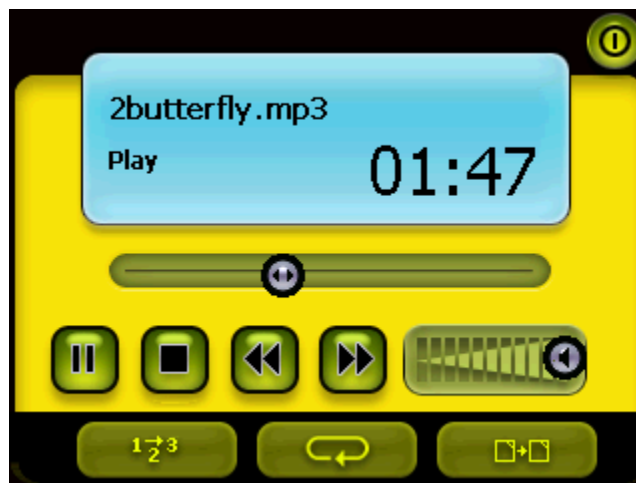

The selected file will automatically be played. Files in the same directory will also be played provided the Repeat function is disabled.

To control file playback:

The icons in the playback pad let you control the playback mode.



-  /  – Tap to pause or resume playback.

-  – Tap to stop playback.
-  – Hold and drag the slider of the progress bar to adjust the progress of the current track.
-  – Tap to skip backward to the previous track. If the current file is the first track in the list, the last track will be played.
-  – Tap to skip forward to the next available track. If the current file is the last track in the list, the first track will be played.

 You can also move the joystick left/right to skip to the previous/next track. Pressing the joystick during file playback will revert the screen to the Main Menu panel.

To rearrange the playback sequence:

Each directory containing supported music files is considered a playlist. You can choose to shuffle the playback sequence to play files in random order.

- To enable the Shuffle mode, tap .

An enabled Shuffle mode is indicated by the word 'Random' on the playback display pad, and a fade-out Random icon.

- To disable the Shuffle mode, tap the fade-out  button.

 Tapping  will automatically disable the Shuffle mode.

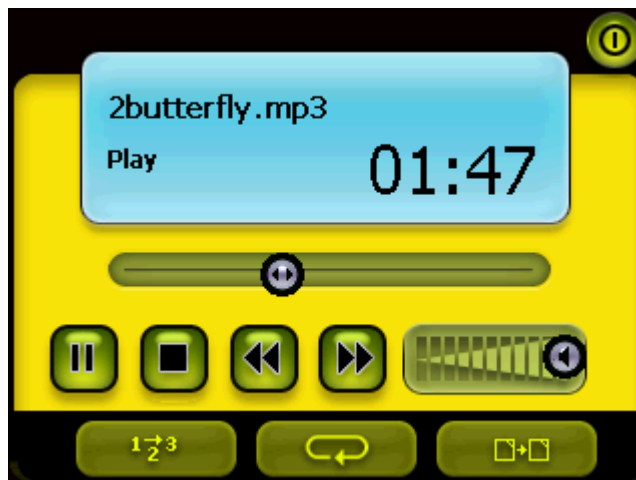

To enable/disable the Repeat mode:

The Repeat mode lets you play the current track in a loop. The same track will be played over and over again until you disable the Repeat mode.

- To enable the Repeat mode, tap .

An enabled Repeat mode is indicated by the word 'Repeat' on the playback display pad, and a fade-out Repeat icon.

- To disable the Shuffle mode, tap the fade-out  button.



Tapping  will automatically disable the Repeat mode.

To control the playback volume:

To adjust the playback volume, you can use either the *MP3* volume control slider or the volume control hot keys.

- Hold and drag the slider of the volume progress bar . This will only affect the volume of the track playback.
- Press the volume hot keys $+/-$ will adjust the sound level for the device's system sounds.

Photo

These days every mobile gaDestinator OPet seems to be equipped with a digital camera, better for capturing that spontaneous moment. With NAV 350 you can keep these images of your favorite moments as mobile as you are by using *Photo*. The program features:

- Support for JPEG and BMP (1-, 4-, 8-, and 24-bit) files
- Auto-scanning of supported files in the device's SD/MMC card.
- Three viewing modes: Thumbnail, Full Screen, and Slide Show
- Album support based on sub-directory contents

Each sub-directory containing compatible image files is treated as an individual album. For a more organized file search, it is advisable to sort image files into sub-directories based on something, such as a particular event or a certain period. To illustrate, a sub-directory containing pictures from your daughter's birthday can be named "Cassie's 10th birthday"; or "May 11 to June 24 log" for a sub-directory consisting of pictures taken during that period.

Using Photo

To open Photo:



- Tap  on the Main Menu panel.

The program will automatically scan the device's SD/MMC card for supported image files. Image files will be displayed as thumbnails; only sub-directories containing compatible files will be displayed.



Tap  /  or use the joystick to scroll through all available files. When a thumbnail is selected, a red border appears around it.



Viewing files in Full Screen mode

In Full Screen mode, image files can be viewed in a larger or smaller scale. You can also change its orientation angle.

To open image files in Full Screen mode:

1. Search for the file you want to view.

Tap  /  or use the joystick to scroll through all available files.

Tap  to return to the device's root directory.

2. Open the file in full screen mode.
 - o When the file is located in the root directory, tap the file.
 - o When the file is located inside a sub-directory, tap the sub-directory icon, then tap the file you want to view.



Tap to view files in Full Screen mode

- Tap  or move the joystick left/up to display the previous available image file.

- Tap  or move the joystick in a right/down direction to display the next available image file.

To change the image magnification level:



- Tap  or press the Zoom In hot key **+** to zoom into the center of the image.

When in a Zoom In state, you can hold and drag the image to pan it in any direction you want.



- Tap  or press the Zoom Out hot key **-** to zoom out the image display.
- To change the image orientation:



- Tap  to rotate the images 90° clockwise.

To return to Thumbnail mode:

- Tap screen or press the joystick.

Viewing files in Slide Show mode

You have the option to view images in a slide show much like viewing a PowerPoint presentation in your computer. Images are adjusted to fit the entire display area and are shown in a 3-second interval.

To enable the Slide Show mode:

- In Thumbnail mode, tap 



Tap the touch screen or press the joystick to stop the slide show and return to the previous viewing mode.

System configuration

This chapter describes the ways you can customize the NAV 350 by setting user preferences.

System settings overview

You can adjust the settings of the device to suit the way. Adjusting certain settings, such as those for system volume, power LED, and hot keys/ touch screen backlight may increase the standby time.

To access the System panel:

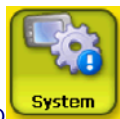

- Tap  on the [Main Menu](#) panel.







There are six preferences icon on this panel:



-  - Tap to set the volume level for system sounds and enable tapping sound.



-  - Tap to view the battery power level and enable the hot keys backlight.



-  - Tap to set the touch screen backlight level and enable its auto-off function.
-  - Tap to change the system date, time, and time zone settings.
-  - Tap to set the language option for the system menus and voice prompts.
-  - Tap to displays your device's model name and related technical specifications. Options for factory reset, GPS reset, and screen recalibration are also shown.

Customizing user preferences

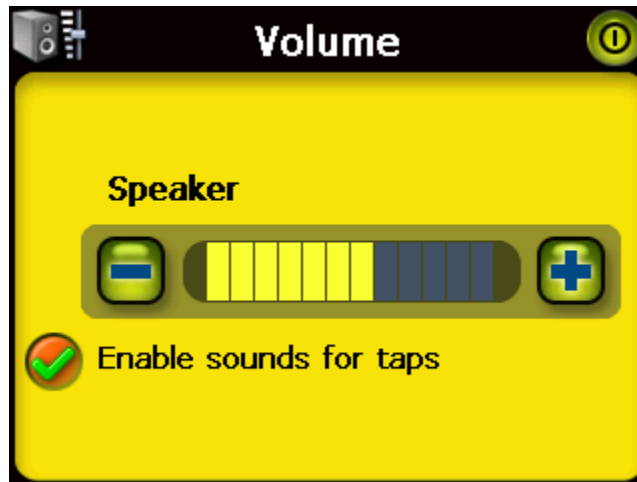
Volume



To set the system sounds volume level:

1. Tap  /  to adjust the volume level.
2. Tap  to apply the changes made.



To enable tap sounds:

1. Tap the **Enable sounds for taps** check box.

2. Tap  to apply the changes made.

PowerTo enable the hot keys backlight:

1. Tap the **Hot keys backlight on when pressed** check box.

2. Tap  /  to set the hot keys backlight's auto-off function. Options include backlight off after 5, 10, 15, and 20 seconds.



3. Tap  to apply the changes made.

To enable the hot keys backlight when running on AC power:

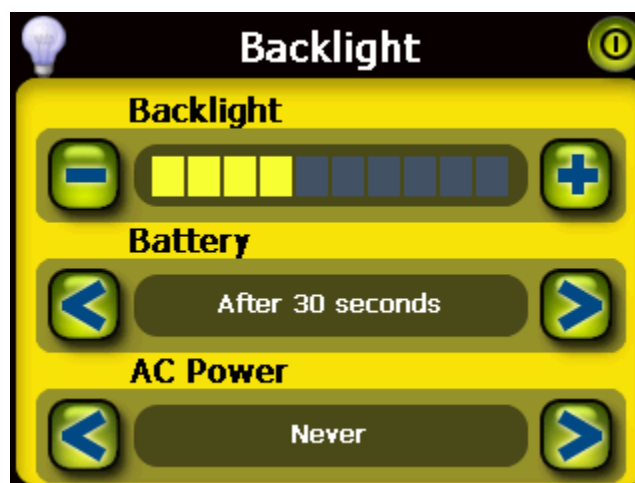

1. Tap the **Hot keys backlight on when AC-in** check box.

Tap Backlight

To set the screen backlight level:

1. Tap  /  to adjust the screen backlight level.
2. Tap  to apply the changes made.

To set the screen backlight auto-off function:

1. Tap  /  under the Battery and AC Power settings.
Options include Never, backlight off after 10 or 15 seconds, and backlight off after 1, 2, or 3 minutes.
2. Tap  to apply the changes made.

Date Time



Go to step 3 of the "[To configure system settings](#)" section for instructions on how to set the system date and time.

Language

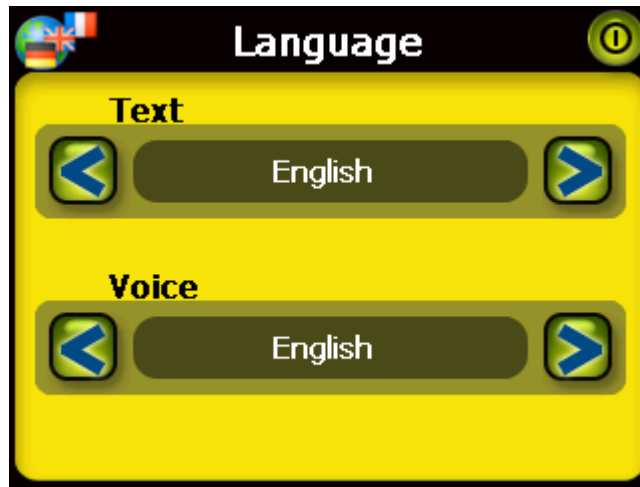

The NAV 350's user interface supports five pre-loaded languages: International English, French, German, Italian, and Spanish. Additional language support is provided in navigation mode (i.e., when using Destinator Destinator OP). This includes English, Italiano, Frangais, Castellano, Deutsch, Portuguese, Nederlands, Danish, Swedish.

Go to step 2 of the "[To configure system settings](#)" section for instructions on how to set the system language.

To load additional language options, refer to the *Destinator OP User's Guide*.



When an additional language is installed and selected, it will only affect the Destinator OP user interface. System menus and non-navigation screens (Contacts, *MP3*, and *Photo*) will default to English.

System Info

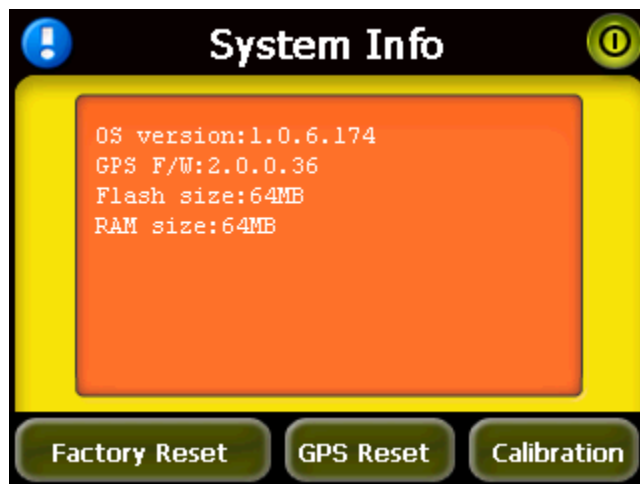

Go to the "[Troubleshooting your NAV 350](#)" section for instructions on how to use the three command buttons on the System Info screen.

System maintenance and user support

This chapter contains information regarding system usage, maintenance, and troubleshooting. Lists of frequently asked questions (FAQs) and user support contact information are also provided for reference.

Using your NAV 350 safely



The precautions and instructions stated in this Guide shall be executed in the English language. In the event of any discrepancy between the English language original hereof and any translation hereof into any other language, the English language original shall govern.

Driving precautions

When using the device in a vehicle, the vehicle operator is solely responsible for operating the vehicle in a safe manner. It is your responsibility to comply with all traffic laws. Failure to follow the directions below could result in death or catastrophic bodily injury to you or to others.

- Do not attempt to enter information or configure the device while driving. If you need to do so, pull out of traffic and come to a stop in a legally permissible and safe location before using your device.
- Vehicle operators must maintain full surveillance of pertinent driving conditions at all times. Minimize the need to view the device screen while driving and use voice prompts to guide you.
- Never place the device on the passenger seat or any place else in the car where it can become a projectile during a collision or stop.
- An air bag inflates with great force. DO NOT mount the device in the area over the air bag or in the air bag deployment area.

- Although reasonable attempt has been made to ensure that the database in your NAV 350 is accurate, such information may change from time to time. The NAV 350 database does not include any of the following:

Legal restrictions (such as vehicular type, weight, height, width, load and speed restrictions)

Road slope, bridge height, weight or other limits

Construction work zones or hazards; road closures, traffic conditions

Weather conditions

Emergency events

It is your responsibility to disregard any unsafe, hazardous or illegal route suggestions. Your judgment and common sense shall take precedence over any information that may be received through the use of your device.

Operating precautions

Device usage precautions

- Do not use your device anywhere it may be exposed to water or in conditions of high humidity.
- Do not expose the device to extreme temperatures, which could occur in a vehicle under direct sunlight. Such exposure can shorten the life of the device, damage the plastic housing and/or battery, and increase the risk of explosion.
- Do not subject your device to sudden and severe temperature changes. This could result in moisture condensation in the device that could cause damage to the device. In the event of moisture condensation, allow the device to dry out completely.
- Do not leave the device unattended on an automobile dashboard. When your vehicle is parked and the device is not in use, protect it from theft and extreme heat by storing it in an unobtrusive location, away from direct sunlight.

- The device is not a toy. Never allow children to play with the device.
- Never touch the liquid that might leak from a broken liquid crystal display. Contact with this liquid could cause a skin rash. If the crystal display liquid should come into contact with the skin or clothing, wash it immediately with clean water.
- Never raise the sound volume level too high when using the device with earphones. An excessive sound volume level could cause damage to your hearing.

Car mount precautions

- Some countries prohibit the mounting of any electronic device in any location on the vehicle dashboard. Be sure to check the local laws for applicable mounting before installing the car mount.
- Some newer vehicle models may have a heat reflective shield embedded in the windshield. This may in some cases obstruct the GPS signal reception. If you encounter this problem in the vehicle, you need to purchase an external GPS antenna.
- The heating and cooling cycle of a vehicle's interior will in some cases loosen the adhesion of the suction cup. Check the vacuum seal of the car mount for adequate adhesion each time you use the unit, and reinstall it if necessary.
- If the car mount has problems staying on, clean the plastic suction cup with alcohol, then reinstall. Moistening the suction cup may help adhesion in some cases.
- To avoid extreme temperature from damaging the car mount, remove the unit if the temperature inside your vehicle exceeds 70°C (160°F).
- The dip in humidity and temperature at night may loosen the adhesion of the suction cup. For this reason, as well as for security, it is recommended that you remove both the car mount kit and the NAV 350 when leaving your vehicle overnight.

Storage precautions

- Do not store the device anywhere it may be exposed to water or in conditions of high humidity.
- When the device is not in use for an extended period of time, bring it indoors and store it in some location with a temperature range of -20° to +70°C (-40° to 140°F) .
-

Cleaning the NAV 350

- Use a damp soft dry cloth to wipe the device's casing (not the display screen). Never use organic solvents such as benzene or paint thinner to clean the device. Use of these solvents can cause deformation or discoloration.
- Use a soft, clean, lint-free cloth to clean the display screen. Moistened LCD screen wipes could also be used as required.

Troubleshooting the NAV 350

Recalibrating the screen

If while using the device, you discover tapping an item doesn't bring up the appropriate response, it means your device has lost its calibration. Recalibrate the screen.

To recalibrate the screen:

3. Tap **System** on the Main Menu panel.



4. Tap **Sys Info.** on the System panel.
 5. Tap **Calibration** on the System Info screen.
 6. Tap the center of the black dot as it moves around the screen.

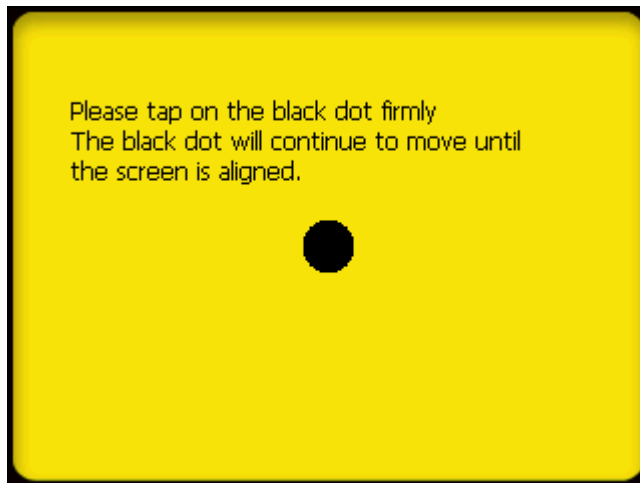

7. Tap **Calibration** to apply the changes made.

Resetting the NAV 350

You may have to perform a reset if the device freezes (i.e., device no longer responds to the buttons on the screen). A soft reset allows your device to get a fresh start, similar to rebooting a computer. This will restart your device and adjust memory allocation. All records and entries are retained after a soft reset. GPS settings are also retained.

To perform a soft reset:

- Hold the device securely, and then press the soft reset button (1) on the bottom of the device.

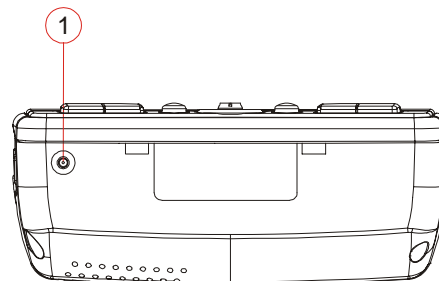

Loading the factory default settings

If you still encounter system errors even after soft resetting the device, load the factory default settings to correct the error. These default settings have been selected to optimize your device's performance.

To load the factory default settings:



1. Tap **System** on the Main Menu panel.



2. Tap **Sys Info.** on the System panel.
3. Tap **Factory Reset** on the System Info screen.
4. Tap **Yes** on the dialog box.



5. After the factory reset, reconfigure your device's user preferences.



Resetting the GPS function

In the following circumstances, the TTFF (Time To Fix First) values of your NAV 350 may be longer than usual.

- After a long period of inactivity
- If the current GPS fix position is more than 500 km, or more than apart 12 hours apart, from the previous position

This is due to the nature of the GPS algorithm and rotational velocity between the satellites and planet Earth, and is deemed normal. To correct this, perform a GPS reset. This will update the GPS database, which contains information about the GPS satellites that the unit needs to function in navigation mode.

To load the factory default settings:

1. Tap  on the [Main Menu](#) panel.
2. Tap  on the [System](#) panel.
3. Tap **GPS Reset** on the [System Info](#) screen.
4. Tap **Yes** on the dialog box.



The GPS reset process will take about a minute to complete.

FAQs

This section lists frequently-asked questions that may arise during the use of your NAV 350, and gives easy answers and solutions to these questions.

Aspect	Question	Answer
Audio	Why is there no sound coming from the device?	<ul style="list-style-type: none"> • If the earphone is plugged into the device, the speaker is automatically shut off. Disconnect the earphone. • Check that the device's volume settings is not muted. In the System panel, tap Volume.
Touch screen	Why is the touch screen not responding to my finger taps?	The screen may have lost its calibration. Recalibrate the screen. Go to the " Recalibrating the screen " section for instructions.

Language setting	When I switched the language setting to Dutch, why do I still get an English Main Menu?	If a user selects a language that is not one of the five pre-loaded options (International English, French, German, Italian, and Spanish), the new setting will only affect the Destinator OP user interface. System menus and non-navigation screens will default to English.
Aspect	Question	Answer
Multimedia mode	Why can't I view my picture files?	You may be trying to view an image that is not supported by <i>Photo</i> . Go to the " Photo " section for a list of supported image formats.
	Why can't I play my music files or view my pictures while navigating?	The device's multimedia programs— <i>MP3</i> and <i>Photo</i> —are not available in navigation mode. This is for safety reasons so as not to distract the driver's attention from the road.
Navigation mode	Why is it that sometimes my device takes longer than 5 minutes to get a GPS fix?	If the previous GPS fix position was more than 500 km or 12 hours apart from your current position and time, it will take significantly longer than the standard TTFF time to get a GPS fix. This is due to the nature of the GPS algorithm and rotational velocity between the satellites and planet Earth, and deemed normal and is not the fault of your NAV 350 device.
	How do I acquire a GPS fix within standard time frame (about 1 minute in general)?	Perform a GPS reset. Go to the " Resetting the GPS function " section for instructions.
System information and performance	How do I check the OS version of my device?	<ul style="list-style-type: none"> Perform a soft reset on the device. Go to the "Resetting the NAV 350" section for instructions. The device's OS version appears on the bottom left corner of the screen. View the device's OS version and other technical specifications. In the System panel, tap Sys Info.
	How do I restore the system back to its default factory settings?	Users can perform this task by using the Factory Reset button on the System Info screen. Go to the " Loading the factory default settings " section for instructions.
	Does performing a factory reset means a GPS reset as well?	No. The Factory Reset function mainly reset the OS settings to their default factory values; it will not cause the GPS settings to reset.
	What should I do if the system stops functioning normally?	Perform a soft reset on the device. Go to the " Resetting the NAV 350 " section for instructions.
Power	I couldn't turn on the device.	The battery power may be depleted. Recharge the device. Go to the " Recharging the device " section for instructions.

Customer support

Technical assistance

If you encounter a problem with your NAV 350, review the following first:

- "[Troubleshooting your NAV 350](#)" section
- "[FAQs](#)" section

Product warranty

Refer to the NAV 350 Portable Navigator

System specifications

This chapter lists the features and operating specifications of the NAV 350.

Hardware features

Aspect	Description
Processor	Samsung S3C2410 266 MHz application processor
GPS chipset	SIRF Star II LP chipset with Xtrac v2 firmware
Memory	<ul style="list-style-type: none">• 64 MB SDRAM for system memory (for user applications and map storage)• 64 MB Flash ROM onboard flash memory (for operating system and embedded applications)
Power	<ul style="list-style-type: none">• High-density rechargeable 2200 mAh Lithium Ion battery<ul style="list-style-type: none">◦ Up to 5 straight hours of operation (backlight in 10% and GPS locked)◦ 4.5 hours charging time from empty to full capacity via car charger or AC adapter• Recharging options<ul style="list-style-type: none">◦ Indoors using the AC adapter◦ On-the-road using either the car charger or the USB cable• Power status LED indicator
Display	<ul style="list-style-type: none">• 3.5-inch screen for a wider viewing angle• 320 x 240 QVGA screen with 16.7M colors for a full-color display• 200-nit LCD provides higher brightness, high contrast, and low power consuming display• TMR (Transmissive with Micro Reflective) technology allows the screen to display well-reproduced images even under bright outdoors lighting.• Hardware backlight control via the power button
Audio	<ul style="list-style-type: none">• 1.5W built-in speaker• 3.5 mm stereo earphone jack on the device

Aspect	Description
Connectivity	<ul style="list-style-type: none"> • USB port • SD/MMC slot
Hardware command interface	<ul style="list-style-type: none"> • Volume control hot keys • Image magnification level hot keys • Main Menu hot key • Navigation hot key • Multi-directional joystick

GPS specifications

Item	Description
Chipset	SIRF Star II LP with Xtrac v2 firmware
Receiver	12 parallel channel, WAAS enabled
Antenna	<ul style="list-style-type: none"> • Integrated patch antenna for optimum satellite pick up at every angle • Optional connection for external antenna when the vehicle's windshield has a heat reflective shield
Navigation software	Destinator OP features include: <ul style="list-style-type: none"> • Destinator Address Manager • Favourite destination hot list • Destination history • Navigation mode support for driving, hiking, and cycling activities • Trip planner
Map database	NAVTEQ digital map database

Item	Description
TTF (Time To Fix First, typical)	<ul style="list-style-type: none"> • Reacquisition: 1 sec. • Hot start: 8 sec. • Warm start: 35 sec. • Cold start: 55 sec.
Accuracy of position fix (horizontal position)	10 m for 90%
Velocity	0.1 m/s
Protocol	<p>NMEA-0183 v3.0 supporting the following commands:</p> <ul style="list-style-type: none"> • GGA • GSV • GGL • RMC • GSA • VTG

Software specifications

Item	Description
Operating system	Microsoft Windows CE .NET 4.2
Navigation software	Destinator OP

Item	Description
Address book	<p>Contacts</p> <ul style="list-style-type: none"> • Maximum capacity of 500 contact entries • Integrated with Destinator OP for faster navigation using address entries as destination points
Contacts management	<ul style="list-style-type: none"> • Contacts for managing contact information on your device • NAV 350 Contacts Manager for managing contact information on your computer • Microsoft ActiveSync for synchronizing contact information between your device and your computer
Multimedia applications	<ul style="list-style-type: none"> • MP3 – supports MP3, WMA, and WAV formats • Photo – supports JPEG and BMP formats

Design and ergonomics

Aspect	Description
Compact and lightweight	<ul style="list-style-type: none">• Dimensions (L x W x H): 97.6 x 113 x 50 mm (3.8 x 4.4 x 2.0 in)• Weight: 300 g (10.6 oz)
User-friendly interface	<ul style="list-style-type: none">• NAV 350<ul style="list-style-type: none">○ Hot keys with dynamic backlight feature○ Quick launch hot keys for Main Menu and Navigation panels○ Control hot keys for volume and image magnification levels○ Multi-directional joystick○ Touch sensitive screen• Car mount<ul style="list-style-type: none">○ Versatile mounting options: windshield or dashboard positioning○ Firm grip suction cup provides a steady vibration-free support○ Swiveling mechanism and axial rod allows for multi-angle adjustment for optimum viewing position• Software<ul style="list-style-type: none">○ Multi-language user interface options: International English, French, German, Italian, and Spanish○ Additional navigation mode language support: Danish, Dutch, Norwegian, Portuguese, and Swedish.○ Contacts-integration with navigation function○ System configuration based on individual user preferences

Aspect	Description
Power-saving options	<ul style="list-style-type: none"> • Auto-off function for touch screen backlight • Auto-off function for hot keys backlight
Mobile design	<ul style="list-style-type: none"> • Suction-based car mount facilitates multi-vehicle usage • Compact and lightweight body makes it easy for users to carry it anywhere • On-the-road recharging options via the car charger and USB cable • Simple, out-of-the-box operation: Mount, dock, and you're on the go. No fussing with screws and cables.
Entertainment function	Pre-loaded software for accessing digital music (<i>MP3</i>) and image files (<i>Photo</i>)
Bundled peripherals	<ul style="list-style-type: none"> • Car mount • Cradle • Car charger • AC adaptor • USB cable
Accessory options	<ul style="list-style-type: none"> • External GPS antenna • Screen protector • Protective carrying bag

Environmental specifications

Aspect	Description				
Temperature	<table> <tr> <td>Operating</td> <td>0° to 45°</td> </tr> <tr> <td>Storage</td> <td>-10° to +60°C</td> </tr> </table>	Operating	0° to 45°	Storage	-10° to +60°C
Operating	0° to 45°				
Storage	-10° to +60°C				
Relative humidity (non-condensing)	<table> <tr> <td>Operating</td> <td>20% to 90% RH</td> </tr> <tr> <td>Non-operating</td> <td>20% to 90% RH</td> </tr> </table>	Operating	20% to 90% RH	Non-operating	20% to 90% RH
Operating	20% to 90% RH				
Non-operating	20% to 90% RH				

Regulatory information

This device fully satisfies the requirements for CE marking when used in a residential, commercial or light industrial environment.

Index

NAV 350

- accessories, 66
- cleaning, 56
- design and ergonomics, 65
- driving precautions, 54
- environmental specifications, 66
- factory default settings, 58
- FAQs, 59
- feature highlights, 4
- fundamentals, 15
- GPS specifications, 63
- hardware specifications, 62
- initial setup, 7
- multimedia mode, 40
- package contents, 7
- peripherals, 66
- product warranty, 61
- regulatory information, 66
- safety information, 53
- serial number, 52
- software specifications, 64
- system configuration, 48
- system information, 52
- system tour, 1
- technical assistance, 61
- troubleshooting, 56
- user preferences, 48

ActiveSync

- creating a partnership, 21
- installation requirements, 18
- installing, 18
- synchronization rules, 38
- synchronizing contacts, 38

audio

- earphone jack, cradle, 6
- earphone jack, device, 3
- hot keys, 2
- speaker, 2
- specifications, 62
- system settings, 49

backlight

- control button, 4
- hot keys, 50
- touch screen, 15

basic operations

- command interface, 27
- hardware interface, 15

battery

- lost data warning, 26
- specifications, 62
- status icons, 25
- viewing status, 50

bottom view, 4

car charger

- parts, 6
- usage, 10

car mount

- ergonomics, 65
- extreme temperature caution, 23
- GPS signal obstruction, 8, 17
- parts, 5
- removing, 24
- troubleshooting, 55
- usage, 23
- usage precautions, 55

car mount bracket

- legal prohibition, 8

car mount kit

- installation reminders, 8
- installing, 8
- parts, 5

command interface

- hot keys, 27
- joystick, 27
- Main Menu panel, 28
- touch screen, 28

Contacts

- creating, 31
- deleting, 34
- editing, 31

- exporting, 32
- importing, 33
- navigating, 32
- opening program, 30
- overview, 30
- Contacts Manager**
 - exporting, 36
 - importing, 37
 - installation procedures, 20
 - opening program, 35
 - overview, 35
- cradle**
 - docking the device, 10
 - parts, 6
 - removing the device, 24
- device release button, 6**
- hardware specifications, 62**
- driving precautions, 53**
- earphone jack**
 - cradle, 6
 - device, 3
- environmental specifications**
 - humidity, 66
 - temperature, 66
- ergonomics**
 - NAV 350, 65
 - car mount, 65
 - dimensions, 65
 - entertainment function, 66
 - mobile options, 66
 - power-saving options, 66
 - software command interface, 65
 - weight, 65
- FAQs**
 - audio, 59
 - language setting, 59
 - multimedia mode, 60
 - navigation mode, 60
 - power, 60
 - system information, 60
 - system performance, 60
 - touch screen, 59
- front panel, 1**
- Full Screen mode, 46**
- GPS specifications**
 - accuracy value, 64
 - antenna, 63
 - chipset, 63
 - map coverage, 64
 - map database, 63
 - navigation software, 63
 - protocols, 64
 - receiver, 63
 - TIFF values, 64
 - velocity value, 64
- hardware procedures**
 - battery recharging, 25
 - SD/MMC slot, 15
 - touch screen backlight, 15
 - USB cable usage, 21
 - using the car mount, 23
- hardware specifications**
 - audio, 62
 - battery, 62
 - command interface, 63
 - connectivity options, 63
 - flash memory, 62
 - GPS antenna, 63
 - GPS chipset, 62
 - GPS receiver, 63
 - processor, 62
 - system memory, 62
- Home panel. *See* Main Menu**
- hot keys**
 - enabling backlight, 50
 - enabling backlight auto-off timer, 50
 - location, 2
 - Main Menu, 2
 - Navigation panel, 2
 - usage, 27
 - Volume down, 2
 - Volume up, 2
 - Zoom in, 2
 - Zoom out, 2
- humidity**
 - non-operating, 66
 - operating, 66
- image files**
 - supported formats, 45
 - viewing, 45

- joystick**
 - limitation, 27, 30
 - location, 2
 - usage, 27
- left panel, 3**
- Main Menu**
 - hot key, 2
 - icons, 28
- memory**
 - flash memory, 62
 - system memory, 62
- MP3 program**
 - controlling playback, 42
 - features, 40
 - opening files, 41
 - opening program, 41
 - playback pad icons, 42
 - playback volume, 44
 - Repeat mode, 44
 - Shuffle mode, 43
 - supported formats, 40
- multimedia mode**
 - FAQ, 60
 - overview, 40
 - safety limitation, 40
 - using MP3, 40
 - using Photo, 45
- music files**
 - playing, 40
 - supported formats, 40
- navigation mode**
 - driving precautions, 53
 - FAQ, 60
 - GPS database limitations, 54
 - GPS reset, 58
 - GPS specifications, 63
- operating precautions**
 - NAV 350, 54
 - car mount, 55
- peripherals tour**
 - car charger, 6
 - car mount, 5
 - cradle, 6
- Photo program**
 - changing image orientation, 47
 - changing magnification level, 46
 - features, 45
 - Full Screen mode, 46
 - opening program, 45
 - panning images, 46
 - Slide Show mode, 47
 - Thumbnail mode, 45
- power**
 - battery level status icons, 25
 - button, 4
 - recharging via AC adapter, 26
 - recharging via car charger, 10
 - status LED indicator, 1
 - viewing battery status, 50
- power connector**
 - cradle, 6
 - device, 3
- power-saving options**
 - hot keys backlight, 50
 - touch screen backlight, 51
- processor, 62**
- rear panel, 1**
- recharging**
 - time, empty to full capacity, 26
 - via AC adapter, 26
 - via car charger, 10
- Repeat mode, 44**
- right panel, 3**
- safety information**
 - cleaning instructions, 56
 - compatible accessories, 56
 - driving precautions, 53
 - operating precautions, 54
 - repair, 56
 - storage precautions, 56
- SD/MMC slot**
 - location, 3
 - usage, 15
- setup procedures**
 - calibrating the device, 11
 - configuring preferences, 12
 - installing the car mount kit, 8
 - overview, 7
 - turning on the device, 11
 - unpacking, 7
- Shuffle mode, 43**
- Slide Show mode, 47**
- soft reset**
 - button, 4

- performing, 57
- software specifications**
 - address book, 65
 - contacts management, 65
 - multimedia, 65
 - navigation, 64
 - operating system, 64
- speaker, 2**
- storage card**
 - inserting into device, 16
 - removing from device, 16
- synchronization**
 - contacts, 38
 - rules, 38
- system configuration**
 - battery status, 50
 - date and time, 51
 - hot keys backlight, 50
 - language, 51
 - overview, 48
 - preference icons, 48
 - system information, 52
 - System panel, 48
 - touch screen backlight, 50
 - volume, 49
- system date**
 - preference icon, 49
 - setting, 13
- system information**
 - preference icon, 49
 - System Info screen, 52
- system language**
 - additional languages, 52
 - loading additional language support, 52
 - preference icon, 49
 - pre-loaded languages, 52
 - setting system default, 12
- System panel**
 - Backlight, 50
 - Date Time, 51
 - icons, 48
 - Language, 51
 - Power, 50
 - System Info, 52
 - Volume, 49
- system reset**
 - factory reset, 58
 - GPS reset, 58
 - soft reset, 57
- system specifications**
 - environmental, 66
 - ergonomics, 65
 - GPS, 63
 - hardware, 62
 - physical dimensions, 65
 - regulatory information, 66
 - software, 64
- system time**
 - preference icon, 49
 - setting, 13
- system time zone**
 - preference icon, 49
 - setting, 14
- system tour**
 - bottom view, 4
 - front panel, 1
 - left panel, 3
 - rear panel, 1
 - right panel, 3
 - top view, 4
- temperature**
 - operating, 66
 - storage, 66
- Thumbnail mode, 45**
- top view, 4**
- touch screen**
 - adjusting the viewing angle, 23
 - location, 2
 - specifications, 62
 - usage, 28
- touch screen backlight**
 - setting auto-off timer, 51
 - setting brightness level, 51
 - usage, 15
- troubleshooting**
 - factory reset, 58
 - GPS reset, 58
 - screen recalibration, 56
 - soft reset, 57
- USB cable**
 - connection, 21
- USB port**
 - location, 3

- usage, 21
- user preferences**
 - date and time, 51
 - hot keys backlight, 50
 - language options, 51
 - power, 50
 - System panel, 48
 - touch screen backlight, 50
 - volume, 49
- volume**

- enabling tap sound, 49
- hot keys, 2
 - setting volume level, 49
- Zoom in hot key**
 - location, 2
 - use in Photo, 46
- Zoom out hot key**
 - location, 2
 - use in Photo, 46